

Put both hands calmly to your chest.

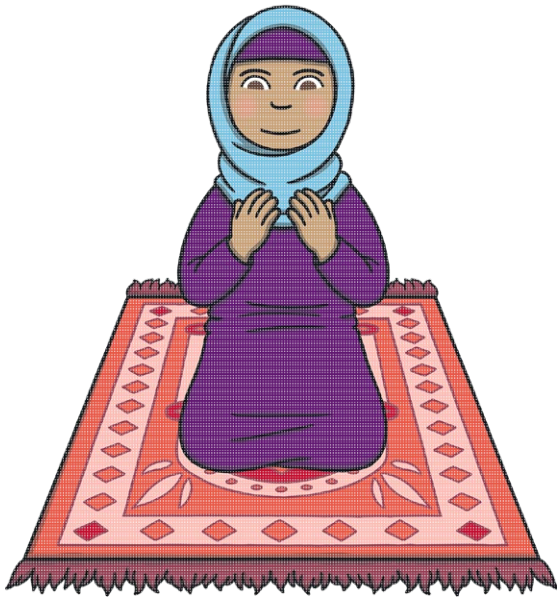

Around the apple, up the stalk and down the leaf. Swing the yoyo up, drop it all the way down and underneath.

pray, may, say

ay

Make a circle with the fingers of each hand and place them together to sign 'b' for boy.

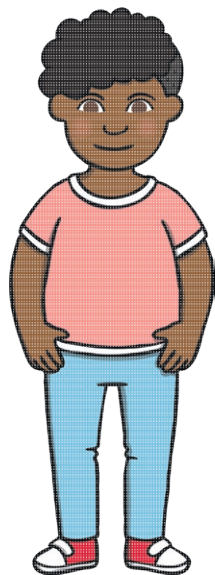

Around the orange. Swing the yoyo up, drop it all the way down and underneath.

boy, toy, joy

oy

Pretend your fist is the knot of a tie and
put it on your chest.

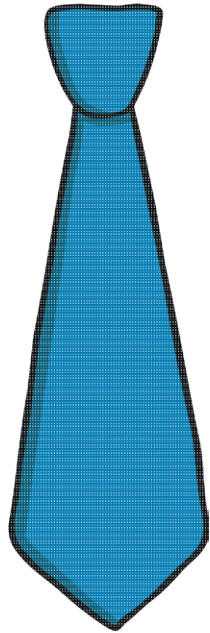

Down the insect's body and tail, dot the
head. Around the egg and under the cup.

tie, pie, lie

ie

Flutter your hand like a leaf blowing
around on a tree.

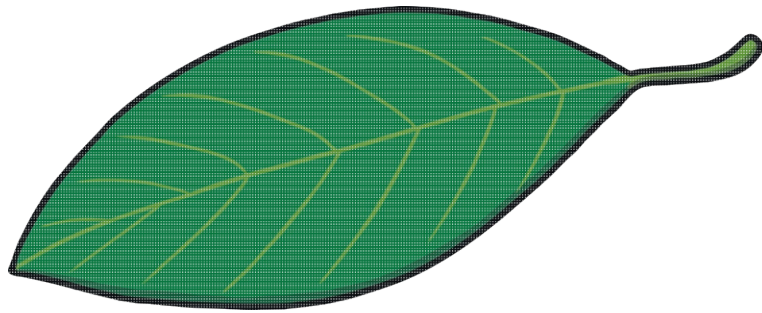

Around the egg and under the cup. Around
the apple, up the stalk and down the leaf.

leaf, sea, bead

ea

Hold both your hands flat in front of you and pretend to blow out the candles on a cake.



Around the apple, up the stalk and down the leaf. Around the egg and under the cup.

cake, snake, rake

a _ e

Slide your arm down and across in front of you.



Down the insect's body and tail, dot the head. Around the egg and under the cup.

slide, bike, time

i_e

Touch a bone in your forearm.

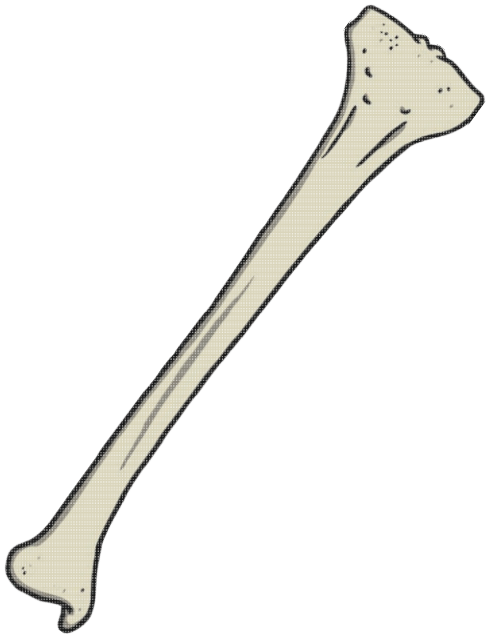

Around the orange. Around the egg and
under the cup.

bone, home, note

o _ e

Make a cube with your hands.

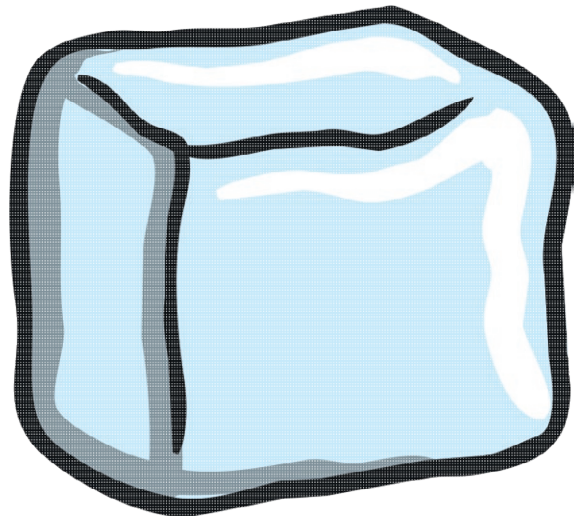

Down one umbrella handle, up and
down the other. Around the egg and
under the cup.

cube, fume, tube

u _ e

Pretend to play a flute with both hands.

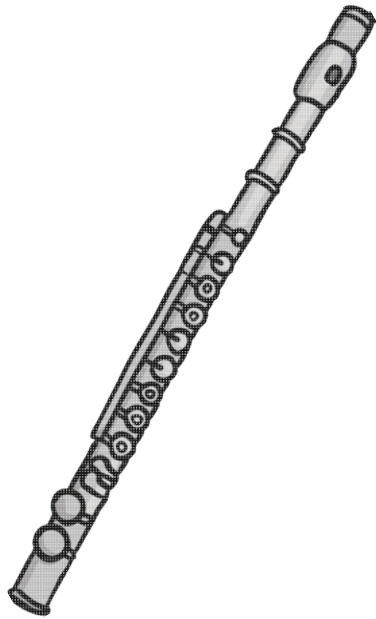

Down one umbrella handle, up and down the other. Around the egg and under the cup.

flute, rule

u _ e

Pretend to hold onto a trapeze bar above your head.



Around the egg and under the cup. Around the egg and under the cup.

trapeze, theme, concrete

e _ e

Point to your mouth.

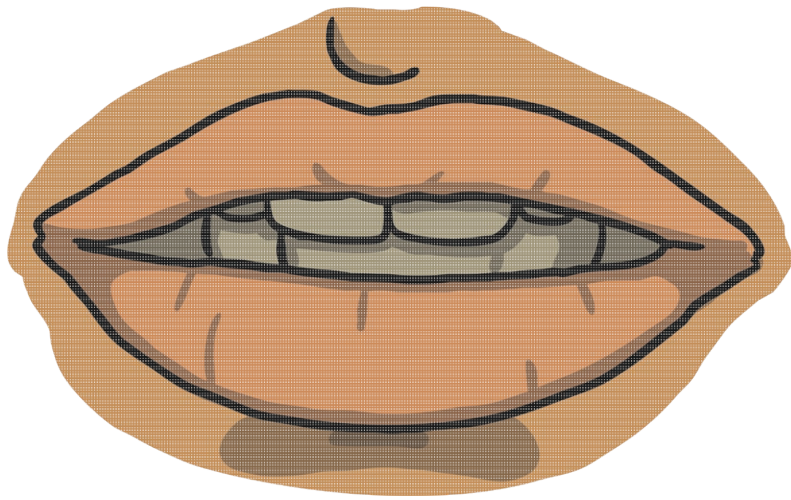

Around the orange. Down one umbrella handle, up and down the other.

mouth, out, cloud

ou

Pretend one clenched fist is an acorn and
cup it in your other hand.

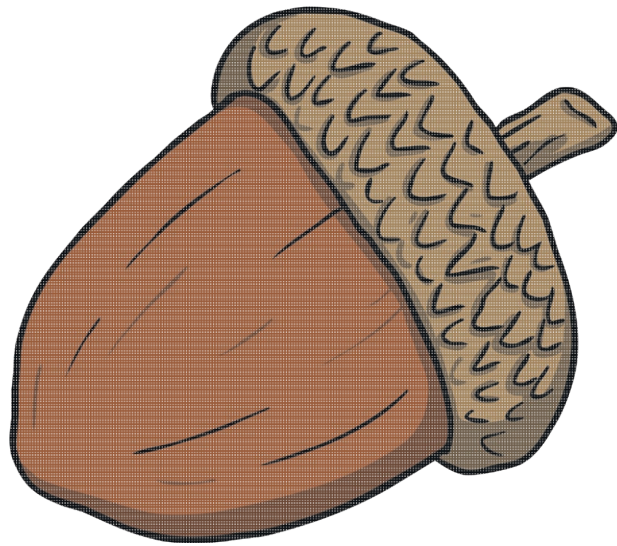

Around the apple, up the stalk and
down the leaf.

acorn, apricot

a

Make a set of balance scales with your arms and pivot your elbows up and down until they are equal.

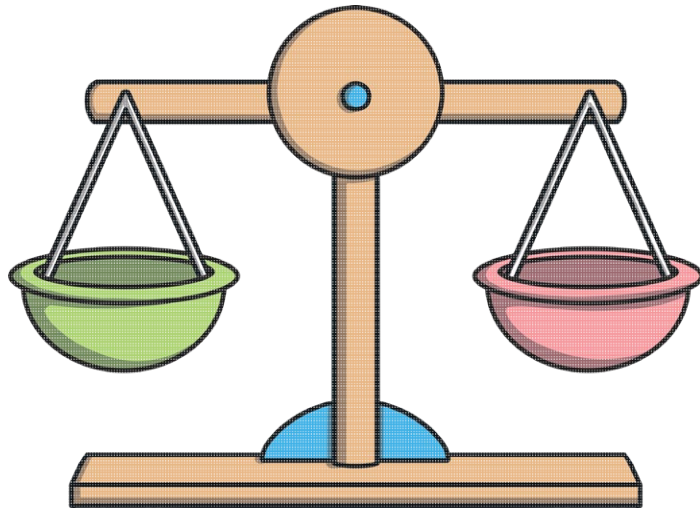

Around the egg and under the cup.
equal, erase

e

Show your teeth and claws like a lion.

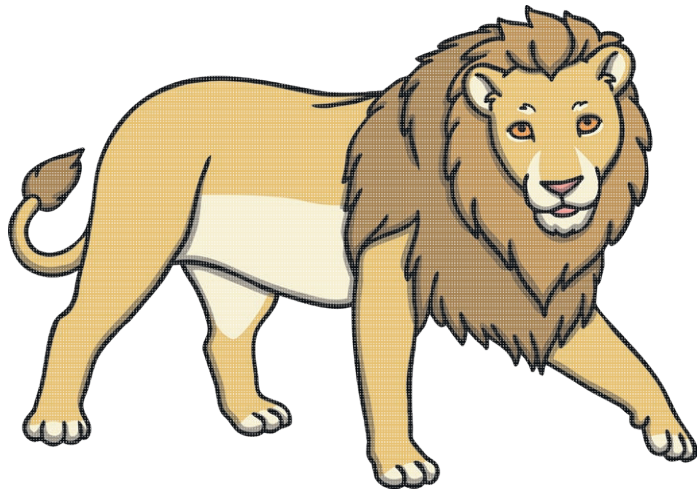

Down the insect's body and tail,
dot the head.

lion, kind

i

Stack your hands in turn one above the other, to build a tall hotel.



Around the orange.

hotel, both

O

Place your hands together like a unicorn
horn on your forehead.

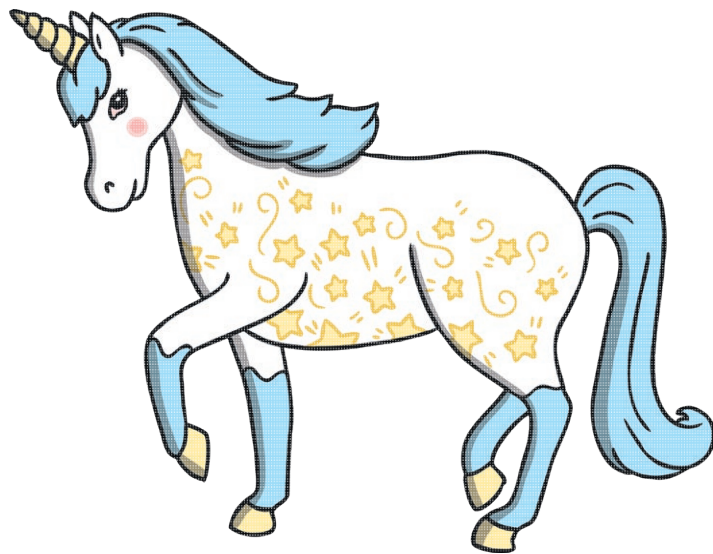

Down one umbrella handle, up and down
the other.

human, unicorn

u

Open and close each hand in turn, like
lights flashing on a Christmas tree.



Curl around the caterpillar. Down the
chimney to the floor, up and over the new
front door.

Christmas, chemist, school

ch

Pretend to hold a chef's bowl in one hand
and mix it with a spoon in the other.



Curl around the caterpillar. Down the
chimney to the floor, up and over the new
front door.

chef, parachute

ch

Place one fist on top of the other, to sign
'g' for girl.

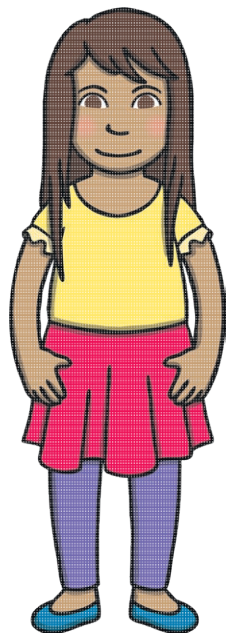

Down the insect's body and tail, dot the
head. Down the robot's body, up and
over its arm.

girl, bird, shirt

ir

Hold your hands and upper body very still
in a statue pose.

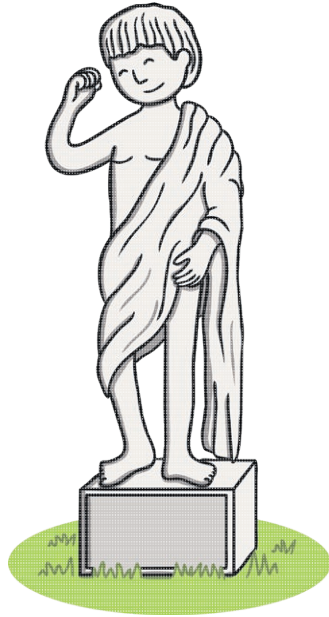

Down one umbrella handle, up and
down the other. Around the egg and
under the cup.

statue, venue, fuel

ue

Hold one hand flat like paper as you pretend to slide a glue stick along it in the other.



Down one umbrella handle, up and down the other. Around the egg and under the cup.

glue, true, clue

ue

Move your hands in a sunny arc above
your head and wriggle your fingers
like sunbeams.

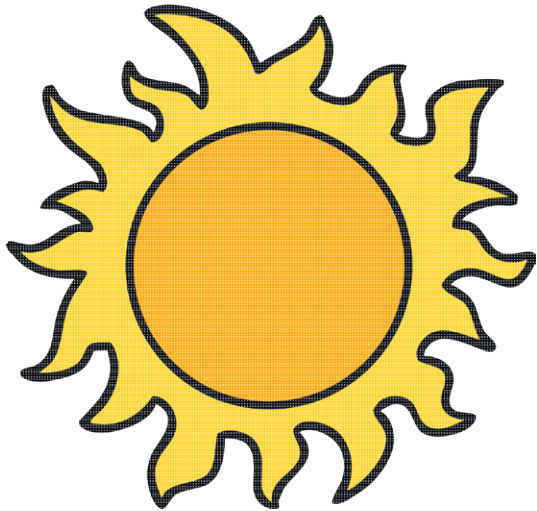

Swing the yoyo up, drop it all the way
down and underneath.

sunny, happy, funny

y

Pretend to screw your finger into your other hand.

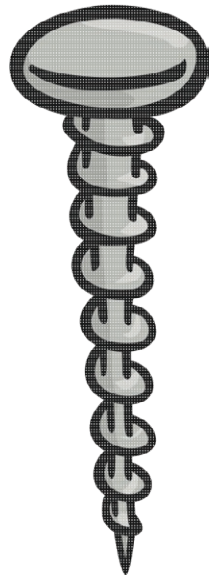

Around the egg and under the cup. Down
the wave, up the wave, down the wave,
up the wave.

screw, drew, grew

ew

Pretend one hand is a bowl of stew and scoop some out, using the other hand as a spoon.

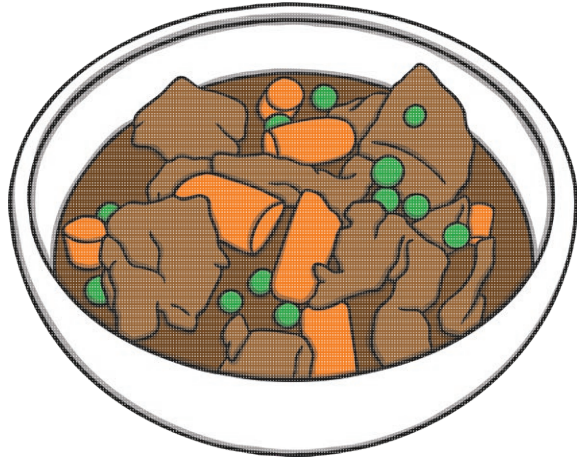

Around the egg and under the cup. Down the wave, up the wave, down the wave, up the wave.

stew, dew, new

ew

Move your hand back and forth in a
sawing motion.

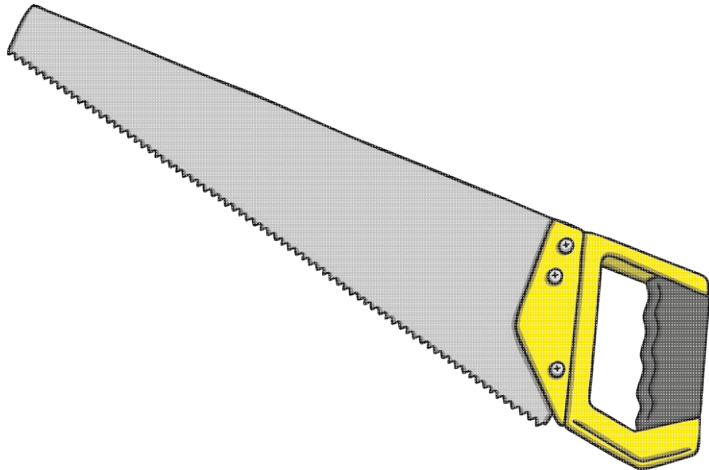

Around the apple, up the stalk and down
the leaf. Down the wave, up the wave,
down the wave, up the wave.

saw, paw, draw

aw

Flutter both of your hands downwards like two falling leaves in autumn.



Around the apple, up the stalk and down the leaf. Down one umbrella handle, up and down the other.

August, autumn, launch

au

Pretend to pull a window wide open.

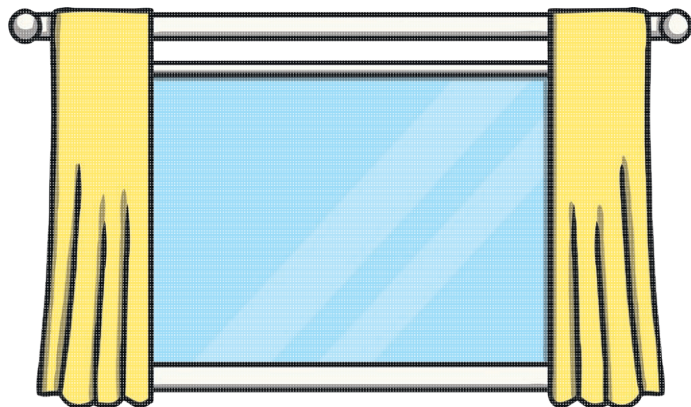

Around the orange. Down the wave, up
the wave, down the wave, up the wave.

window, slow, own

ow

Point to your big toe (can be through your shoes).

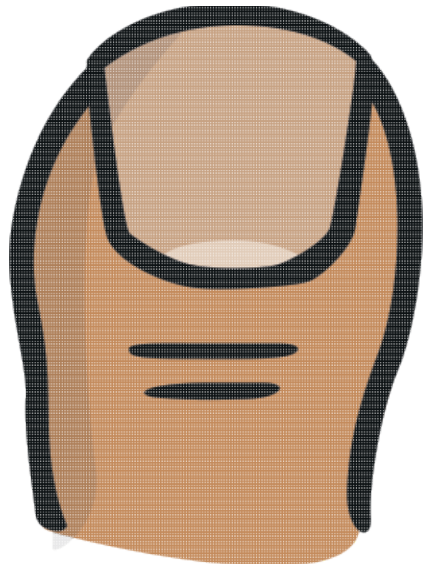

Around the orange. Around the egg and under the cup.

toe, goes, doe

oe

Pretend to hold a steering wheel and
drive a car.

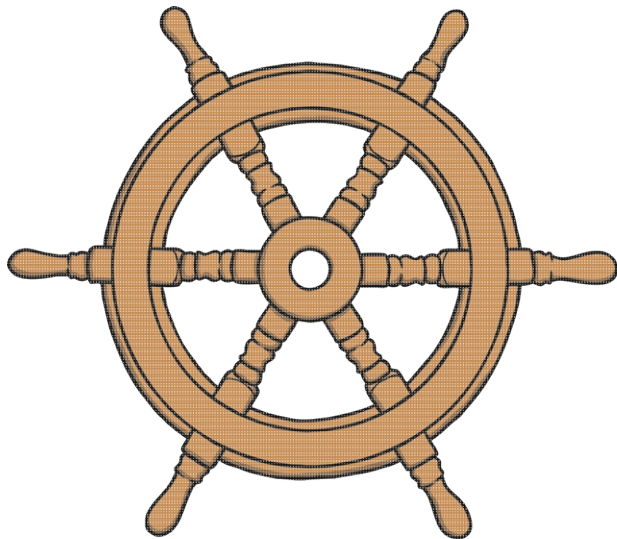

Down the wave, up the wave, down the
wave, up the wave. Down the chimney to
the floor, up and over the new front door.

wheel, white, whale

w h

Pretend to make tall buildings with
your forearms.



Curl around the caterpillar.
city, cell, slice

C

Point to a gem on top of your ring.

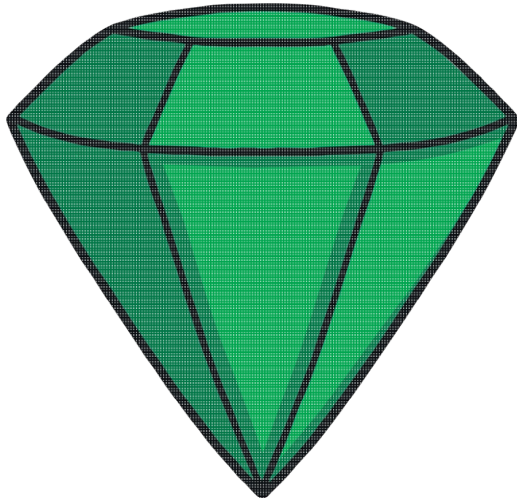

Around Gabi's head and wrap her scarf.

gem, magic, giant

g

Make a leaping dolphin with
your forearm.

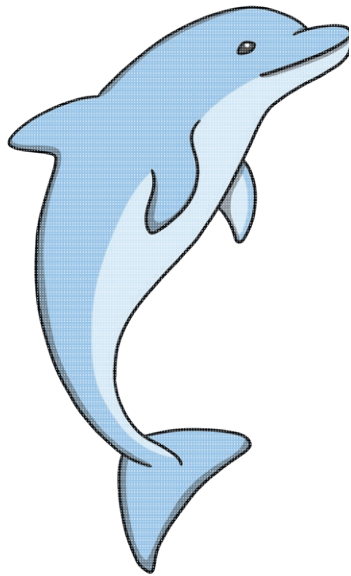

Down the puppy's neck and leg, up and
around his head. Down the chimney to
the floor, up and over the new front door.

dolphin, phone, photo

ph

Pretend to slice a loaf of bread.

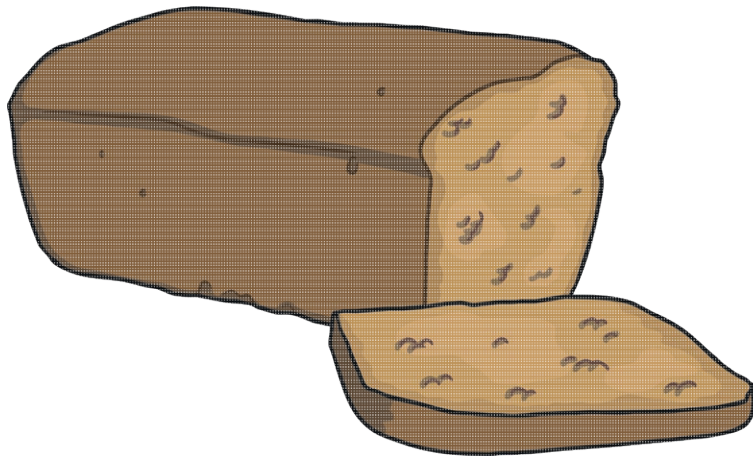

Around the egg and under the cup. Around the apple, up the stalk and down the leaf.

bread, head, deaf

ea

Make a shield by crossing both arms in front of you.



Down the insect's body and tail, dot the head. Around the egg and under the cup.

shield, field, shriek

ie

Make a witch's hat on your head with
your hands.

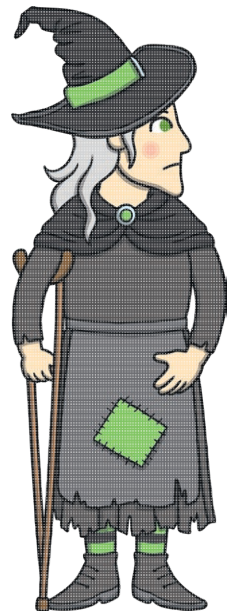

Down the teaspoon and under the teacup,
then across the top. Curl around the
caterpillar. Down the chimney to the floor, up
and over the new front door.

witch, catch, hutch

tch

Point to your bare foot (can be through your shoes).

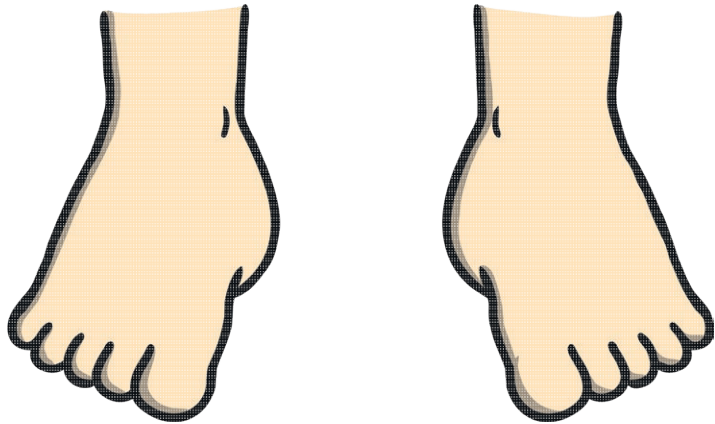

Around the apple, up the stalk and down the leaf. Down the robot's body, up and over its arm. Around the egg and under the cup.

bare, scare, share

are

Pretend to hold and bite into a pear.

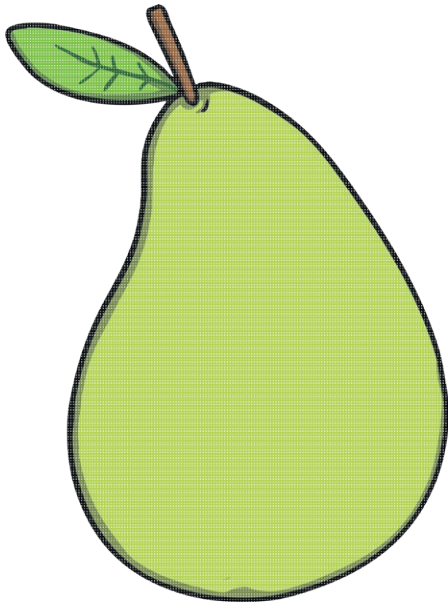

Around the egg and under the cup. Around
the apple, up the stalk and down the leaf.
Down the robot's body, up and over its arm.

pear, bear, wear

ear

Pretend to bite into an apple core made with your finger.

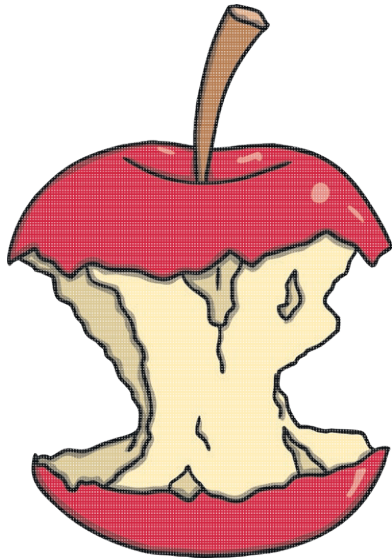

Around the orange. Down the robot's body, up and over its arm. Around the egg and under the cup.

core, score, more

ore